

ArcSource 3 WW™



The Anolis ArcSource 3 combines state of the art LED technology with industry standard MR16 size fixture. Using only the finest materials and precision manufacturing techniques the Anolis ArcSource 3 provides the professional solution for your lighting requirements.

TECHNICAL SPECIFICATIONS:

Power Supply Required: See Below Listing
 Max Power Consumption: 4.2W
 Available Beam Angles: See Pg 5
 Impact Rating: IK **
 Ingress Protection Rating: IP2X
 Light Source: High Power LED's
 LED Life Expectancy: Min 60000 Hrs
 Typical Lumen Maintenance: 70% @ 60000 hrs

Construction: Precision Turned Aluminium
 Fixing Method: Mounting Plate
 Product Weight: 0.15kg
 Operating Ambient Temp Range: -20°C/+40°C
 Operating Temp: +50°C @ Ambient +40°C
 LED Colour Variants: See Pg 5
 Cooling System: Convection
 Cable Type: Cat 5e 1.5m with RJ45 male connector

For further information regarding optical systems please visit the website: www.anolis.eu

Accessories:

Compatible Drivers:

ArcPower 36, 72, 144, 360, 16x6, 16x12, RM 384

DIMENSIONAL DRAWINGS:

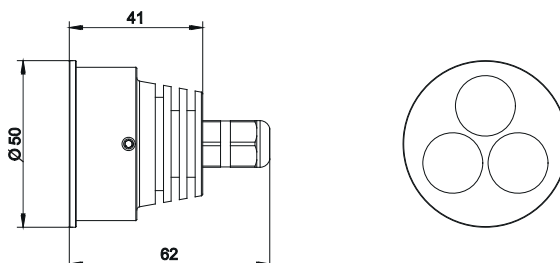

CONNECTION SCHEME:

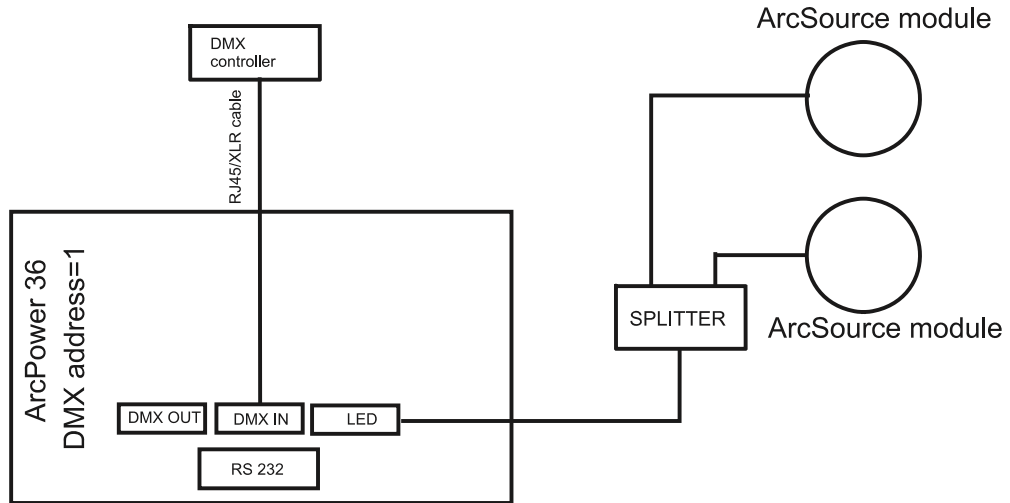

LDC Polar

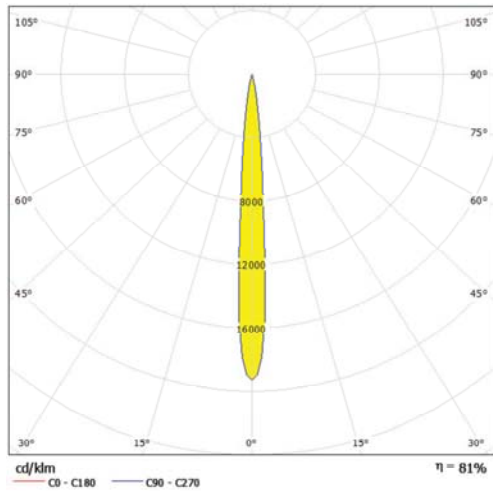

Cone Diagram

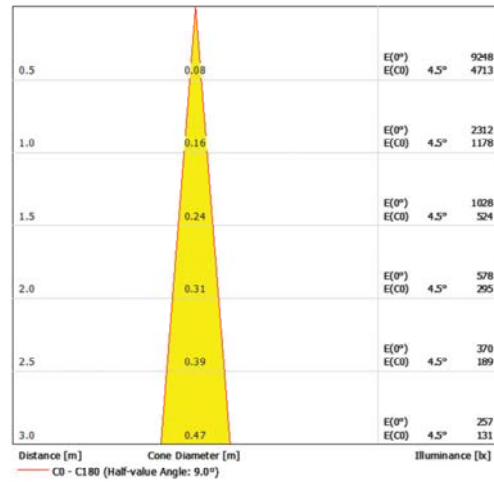

Colour Rendering

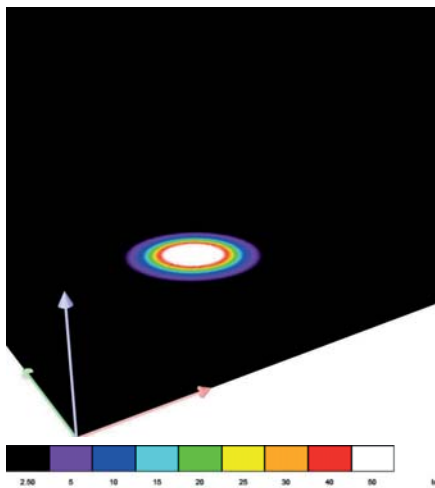

Floor Isolines (E)

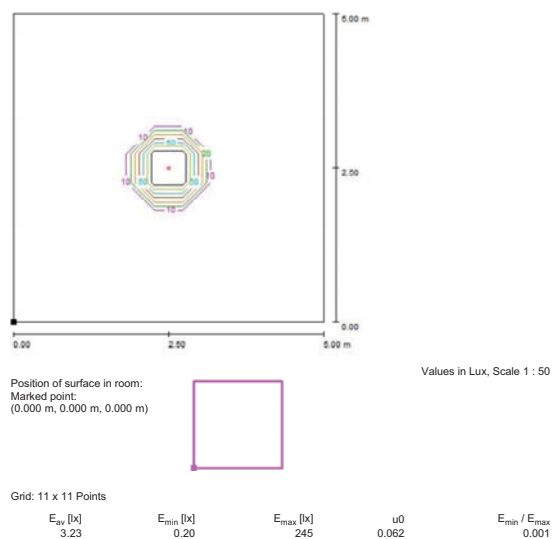

Room Details

Height of working plane: 0.850 m
 Boundary Zone: 0.000 m

Maintenance factor: 0.80

Height of Room: 2.800 m
 Ground area: 25.00 m²

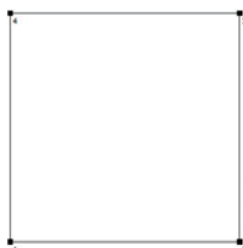

Total Luminous Flux: 120 lm
 Total Load: 7.0 W
 Maintenance factor: 0.80
 Boundary Zone: 0.000 m

Surface	Rho [%]	from ([m] [m])	towards ([m] [m])	Length [m]
Floor	20	/	/	/
Ceiling	70	/	/	/
Wall 1	50	(0.000 0.000)	(5.000 0.000)	5.000
Wall 2	50	(5.000 0.000)	(5.000 5.000)	5.000
Wall 3	50	(5.000 5.000)	(0.000 5.000)	5.000
Wall 4	50	(0.000 5.000)	(0.000 0.000)	5.000

LDC Polar

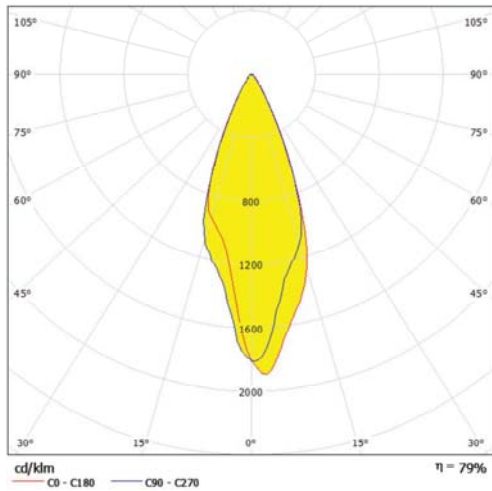

Cone Diagram



Colour Rendering

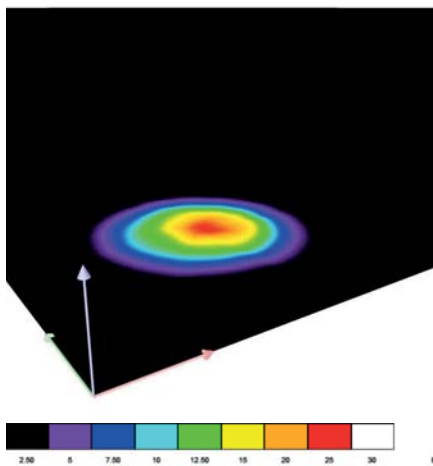

Floor Isolines (E)

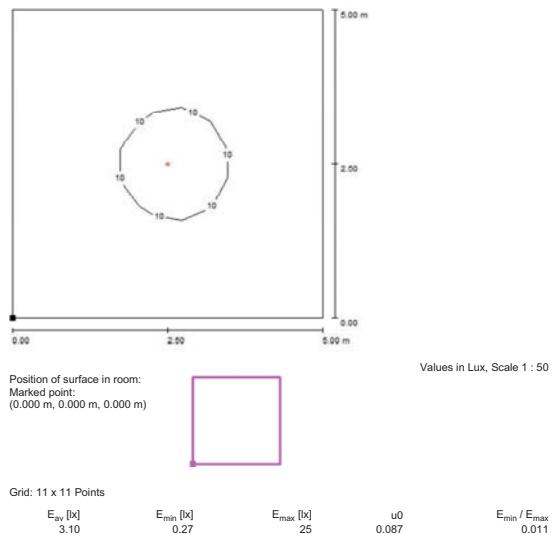

Room Details

Height of working plane: 0.850 m
Boundary Zone: 0.000 m

Maintenance factor: 0.80

Height of Room: 2.800 m
Ground area: 25.00 m²

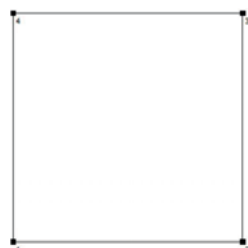

Total Luminous Flux: 120 lm
Total Load: 7.0 W
Maintenance factor: 0.80
Boundary Zone: 0.000 m

Surface	Rho [%]	from ([m] [m])	towards ([m] [m])	Length [m]
Floor	20	/	/	/
Ceiling	70	/	/	/
Wall 1	50	(0.000 0.000)	(5.000 0.000)	5.000
Wall 2	50	(5.000 0.000)	(5.000 5.000)	5.000
Wall 3	50	(5.000 5.000)	(0.000 5.000)	5.000
Wall 4	50	(0.000 5.000)	(0.000 0.000)	5.000

PRODUCT SPECIFICATION CHART:

1006 6101	A	19°
1006 0108	A	25°
1006 6108	A	28°
1006 0110	A	9°
1006 5107	B	19°
1006 0107	B	25°
1006 6106	B	28°
1006 5102	B	9°
1006 1948	BBCW	19°
1006 1949	BBCW	28°
1006 1950	BBCW	25°
1006 5103	CW	19°
1006 0104	CW	25°
1006 6103	CW	28°
1006 0109	CW	9°
1006 5109	G	19°
1006 5108	G	25°
1006 6107	G	28°
1006 5110	G	9°
1006 2015	NW	25°
1006 5105	R	19°
1006 0106	R	25°
1006 6105	R	28°
1006 5106	R	9°
1006 0102	RGB	19°
1006 0101	RGB	25°
1006 6102	RGB	28°
1006 1953	RGB (White)	28°
1006 0103	RGB	9°
1006 1926	SW	9°
1006 5104	WW	19°
1006 0105	WW	25°
1006 6104	WW	28°
1006 5101	WW	9°

ACCESSORIES:

1703 0257	MR16 Housing
-----------	--------------

Other variants available on request