

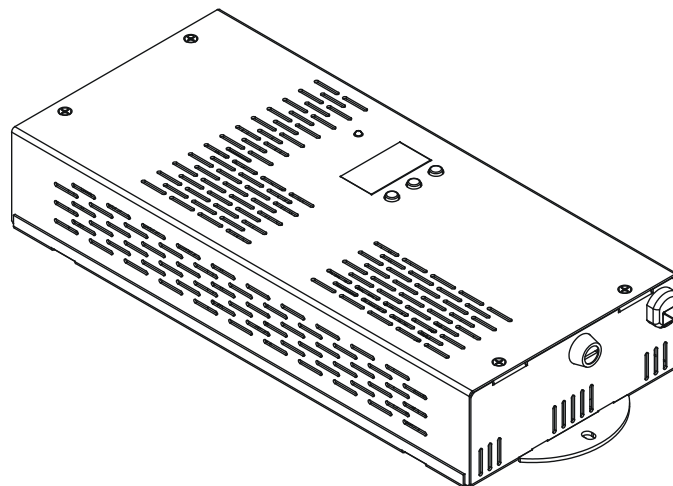

ArcPower SmartWhite 36/K2



USER MANUAL

ArcPower SmartWhite 36/K2

Table of contents

1. Safety instructions	3
2. Operating determinations	3
3. Description of the ArcPower SmartWhite 36/K2	4
4. Installation	4
4.1. Connection to the mains	4
4.2. Mounting the ArcPower SmartWhite 36/K2.....	5
4.3. Connection cables.....	5
5. Installing instructions	6
5.1. DMX operating	6
5.2. Master-slave operating.....	8
5.3. Operating via DyNet protocol	9
6. ArcPower SmartWhite 36/K2 - Control menu map	10
7. ArcPower SmartWhite 36/K2 - DMX protocol	11
8. Control board	12
8.1 Addressing the ArcPower SmartWhite 36/K2	12
8.2 Program running	12
8.3 Manual mode	13
8.4 Test sequences.....	13
8.5 Stand-alone mode.....	14
8.6 Special functions	14
9. Technical Specifications	17

CAUTION!
Unplug mains lead before opening the housing!

**FOR YOUR OWN SAFETY, PLEASE READ THIS USER MANUAL CAREFULLY
BEFORE YOU INITIAL START - UP!**

1. Safety instructions

Every person involved with installation and maintenance of this product has to:

- be qualified
- follow the instructions of this manual

CAUTION!
***Be careful with your operations. With a high voltage you can suffer
a dangerous electric shock when touching the wires inside the unit!***

This product has left our premises in absolutely perfect condition. In order to maintain this condition and to ensure a safe operation, it is absolutely necessary for the user to follow the safety instructions and warning notes written in this manual.

***To prevent from danger of accident ,the device has to be fixed on flat, non-f lam-
mable surface in compliance with the installing instruction included in this manual.***

Important:

The manufacturer will not accept liability for any resulting damages caused by the non-observance of this manual or any unauthorized modification to the product.

Always ground the unit.

The electric connection, repairs and servicing must be carried out by a qualified employee.

Do not connect this unit to a dimmer pack.

Use a source of AC power that complies with local building and electrical rules. AC power has to have both overload and short circuit protection

2. Operating determinations

This product was designed for indoor use with K2 Luxeon LEDs modules only. In case of connecting 1W LEDs modules, the LEDs will be destroyed!

If the unit has been exposed to drastic temperature fluctuation (e.g. after transportation), do not switch it on immediately. The arising condensation water might damage your unit. Leave the unit switched off until it has reached room temperature.

Avoid brute force when installing or operating the unit.

When choosing the installation-spot, please make sure that the unit is not exposed to extreme heat, moisture or dust.

Only operate the unit after having checked that the housing is firmly closed and all screws are tightly fastened.

The maximum ambient temperature 40° C must never be exceeded.

Operate the unit only after having familiarized with its functions. Do not permit operation by persons not qualified for operating the unit. Most damages are the result of unprofessional operation!

Please use the original packaging if the product is to be transported.

Please consider that unauthorized modifications on the unit are forbidden due to safety reasons!

3. Description of the ArcPower SmartWhite 36/K2

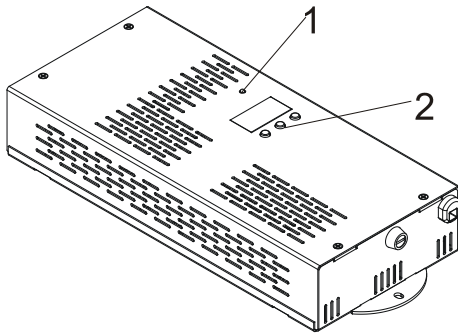

- 1 - Power Indicator
- 2 - Control board
- 3 - DMX Output
- 4 - DMX Input
- 5 - LED Input
- 6 - RS232 input
- 7 - Fuse holder
- 8 - Power cord

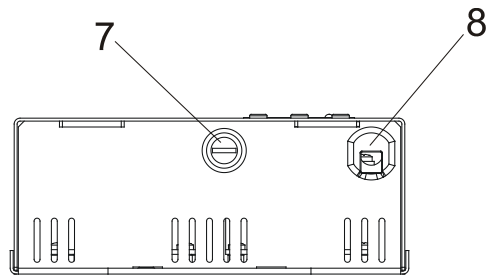
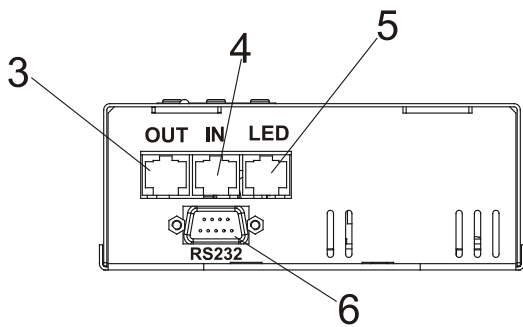

DMX Input, Output

RJ45 socket

Front view of the socket:

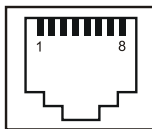

- | | |
|-----------------------------|-----------------------------|
| Pin 1: Not connected | Pin 5: Not connected |
| Pin 2: Not connected | Pin 6: Data + |
| Pin 3: Not connected | Pin 7: Data - |
| Pin 4: Not connected | Pin 8: GND |

LED module Input

RJ45 socket

Front view of the socket:

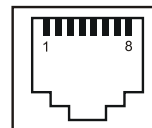

- | | |
|----------------------------------|----------------------------------|
| Pin 1: Warm white LED 1 + | Pin 5: Warm white LED 1 - |
| Pin 2: Cool white LED 1 + | Pin 6: Cool white LED1- |
| Pin 3: Warm white LED 2 + | Pin 7: Warm white LED 2 - |
| Pin 4: Cool white LED 2 + | Pin 8: Cool white LED 2 - |

RS232 Input

Canon 9-pin male

Front view of the socket:

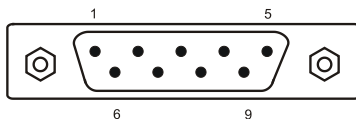

- Pin 1:** Not connected
- Pin 2:** Received Data
- Pin 3:** Transmitted Data
- Pin 4:**
- Pin 5:** Signal Ground
- Pin 6:**
- Pin 7:**
- Pin 8:**
- Pin 9:** Not connected

4. Installation

4.1. Connection to the mains

The ArcPower SmartWhite 36/K2 is equipped with auto-switching power supply that automatically adjusts to any 50/60Hz AC power source from 100-240 Volts.

Carefully prepare the end of the the supply cord and fit a suitable plug. A 3-prong grounding-type plug must be

installed following the manufacturer's instructions. The earth has to be connected!
Cord plug connections:

Cable	Pin	International
Brown	Live	L
Light blue	Neutral	N
Yellow/Green	Earth	

This device falls under protection class I. Therefore the ArcPower SmartWhite 36/K2 has to be connected to a mains socket outlet with a protective earthing connection.

4.2. Mounting the ArcPower SmartWhite 36/K2

The ArcPower SmartWhite 36/K2 should be placed on a non-flammable flat surface in any orientation and fixed by the two screws. There are two mounting holes of diameter 5 mm in housing of the driver. Ensure that installation place is enough ventilated.

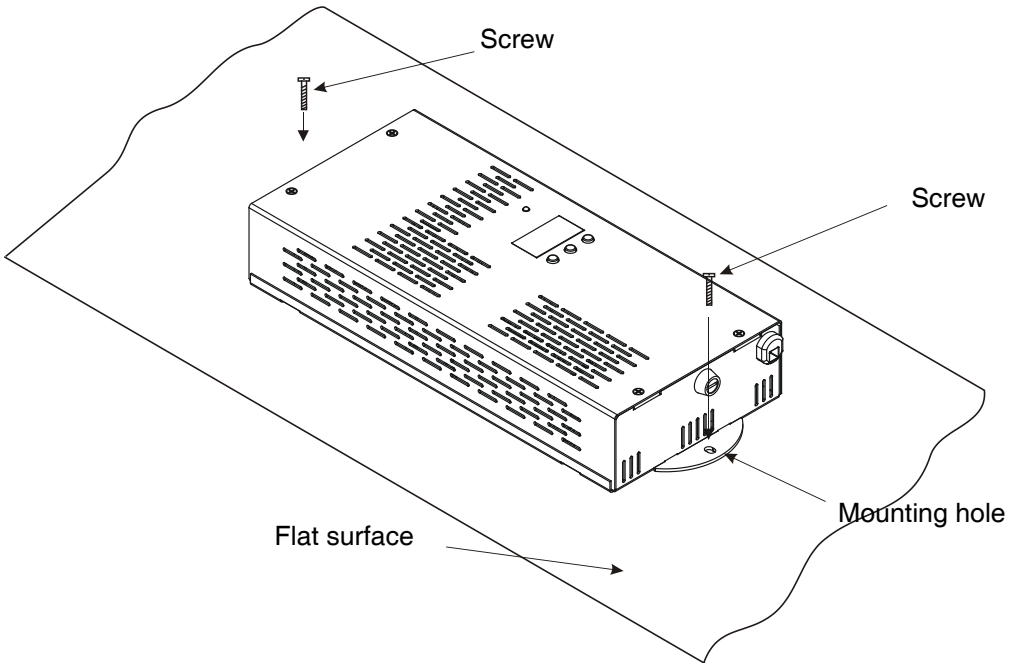

4.3. Connection cables

1. The adapter cable RJ45/XLR connects the ArcPower SmartWhite 36/K2 to the DMX controller. If your DMX controller has RJ45 socket for DMX output, use RJ45 patch cable for connection with the ArcPower SmartWhite 36/K2.

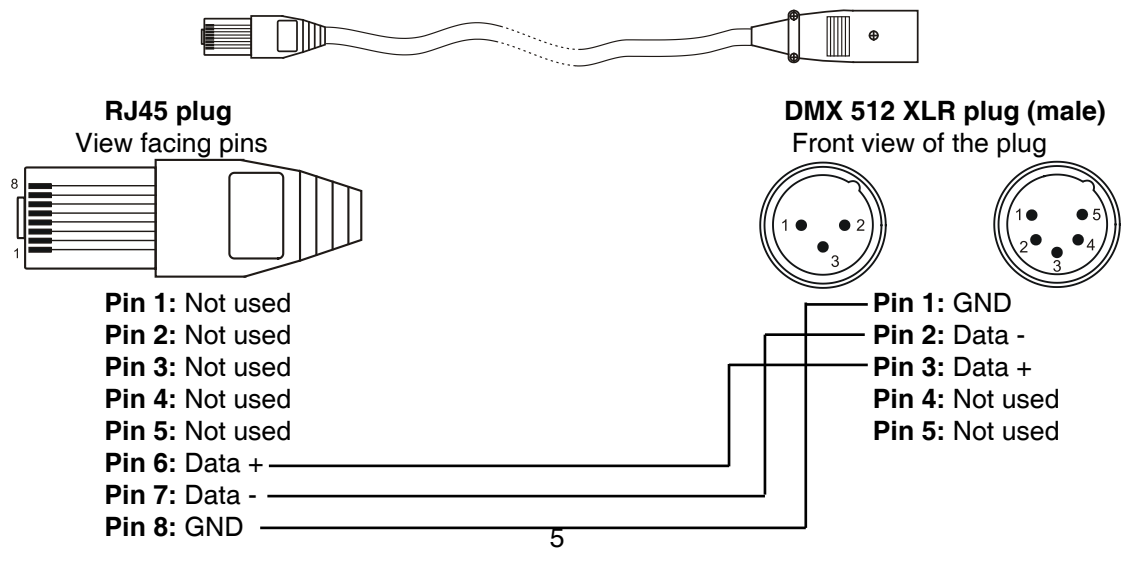

2.RJ45 patch cables category 5 that connect the ArcPower SmartWhite 36/K2 each other are wired 1:1,that is,pins with the same numbers are connected together.



Pin 1: Not used	Pin 1: Not used
Pin 2: Not used	Pin 2: Not used
Pin 3: Not used	Pin 3: Not used
Pin 4: Not used	Pin 4: Not used
Pin 5: Not used	Pin 5: Not used
Pin 6: Data +	Pin 6: Data +
Pin 7: Data -	Pin 7: Data -
Pin 8: GND	Pin 8: GND

5.Installing instructions.

Never connect 1W LEDs modules to the ArcPower SmartWhite 36/K2

5.1.DMX operating

- 1.Unplug from the mains before installation.
- 2.Connect the LED modules to the fixture.Make sure that all modules include K2 Luxeon LEDs.
- 3.Connect DMX controller to the fixture
- 4.Connect the fixture to the mains
- 5.Set the DMX address on the control board of the fixture (see chapter "Control board").

Warning!

**Accidental connection DMX 512 Input/Output to non-DMX 512 device (e.g.Ethernet network Hub) can damage the ArcPower SmartWhite 36/K2.
Maximum total cable length between ArcPower SmartWhite 36/K2 and all connected LED modules is 40 metres.**

Single ArcPower SmartWhite 36/K2 installation:

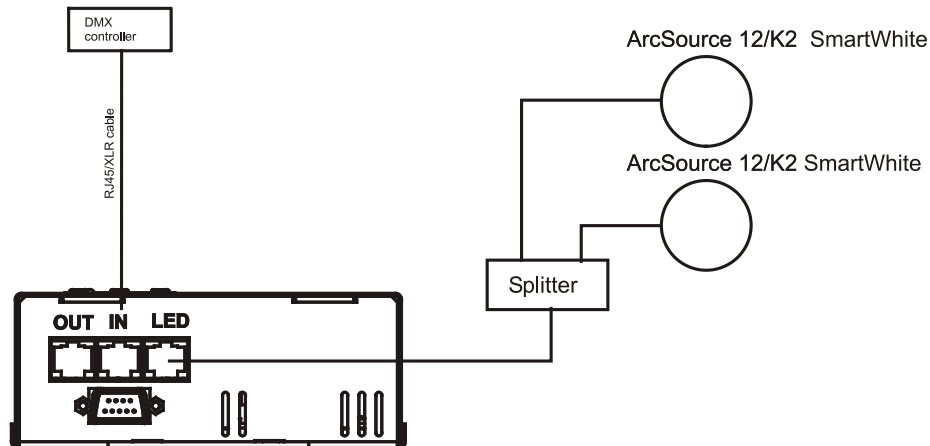

Multiple ArcPower SmartWhite 36/K2 installation:

Connect the DMX output of the first ArcPower SmartWhite 36/K2 with the DMX input of the next ArcPower SmartWhite 36/K2. Always connect one output with the input of the next ArcPower SmartWhite 36/K2 until all fixtures are connected. In this way, up to 32 fixtures can be chained together.

At the last ArcPower SmartWhite 36/K2 the data link has to be terminated with a terminator. A termination plug is simply a RJ45 connector with a 120 Ω resistor between pins Data (-) and Data (+). Plug terminator in the DMX output of the last ArcPower SmartWhite 36/K2.

Maximum number of LEDs connected to the one ArcPower SmartWhite 36/K2 is 36.

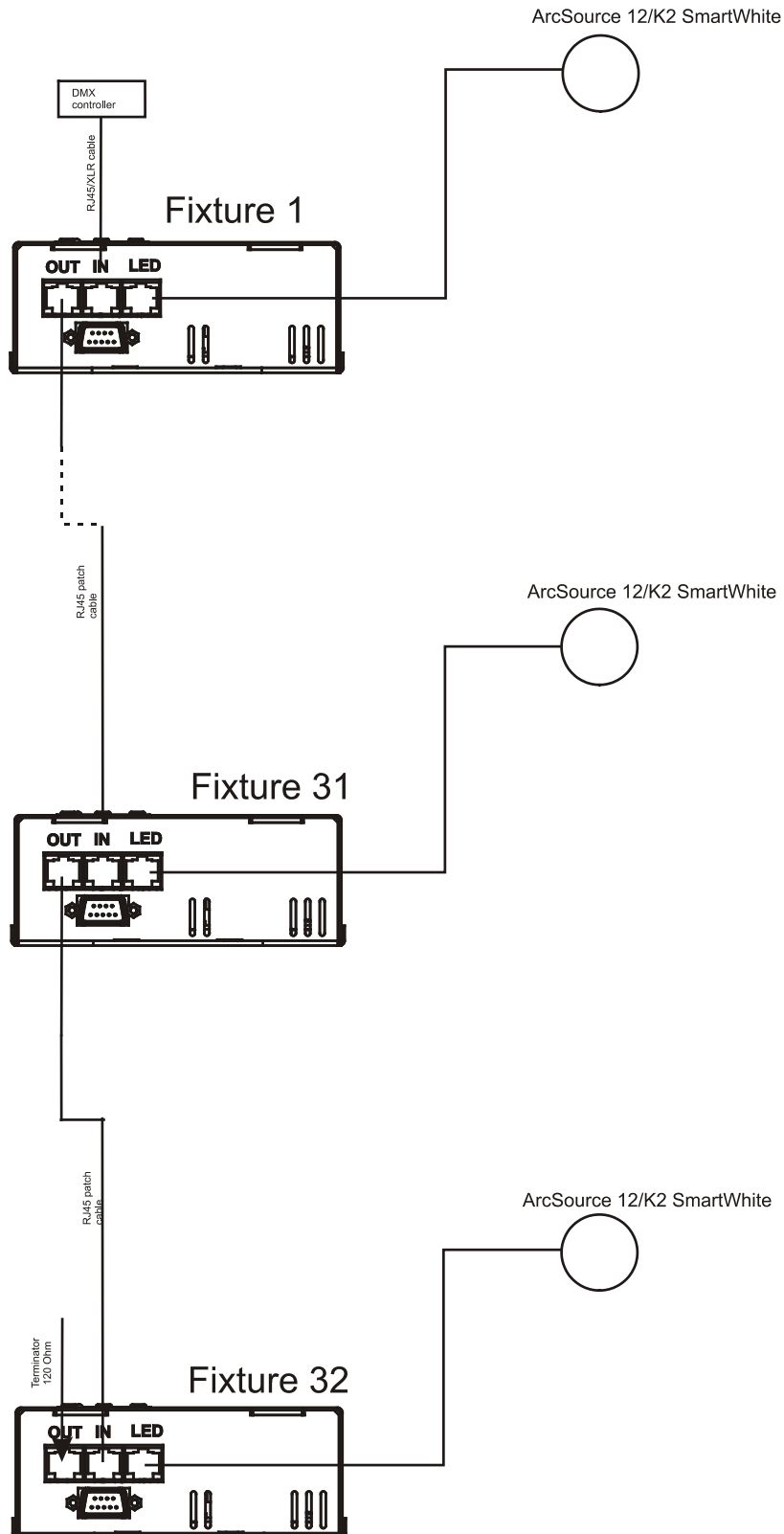

5.2. Master-slave operating

1. Unplug from the mains before installation.
2. Connect the LED module to the fixtures.
3. Connect the DMX output of the master fixture in the data-chain with the DMX input of the first slave. Always connect output with the input of the next slave until all slaves are connected. Up to 32 fixtures can be connected in master/slave chain
4. Insert the termination plug (with 120 Ohm) into DMX input of the master fixture and into the DMX output of the last slave fixture in the link in order to ensure proper transmission on the data link.
5. Connect the fixtures to the mains.
6. See chapter "Stand-alone mode" in order to set the fixture as a master or slave.

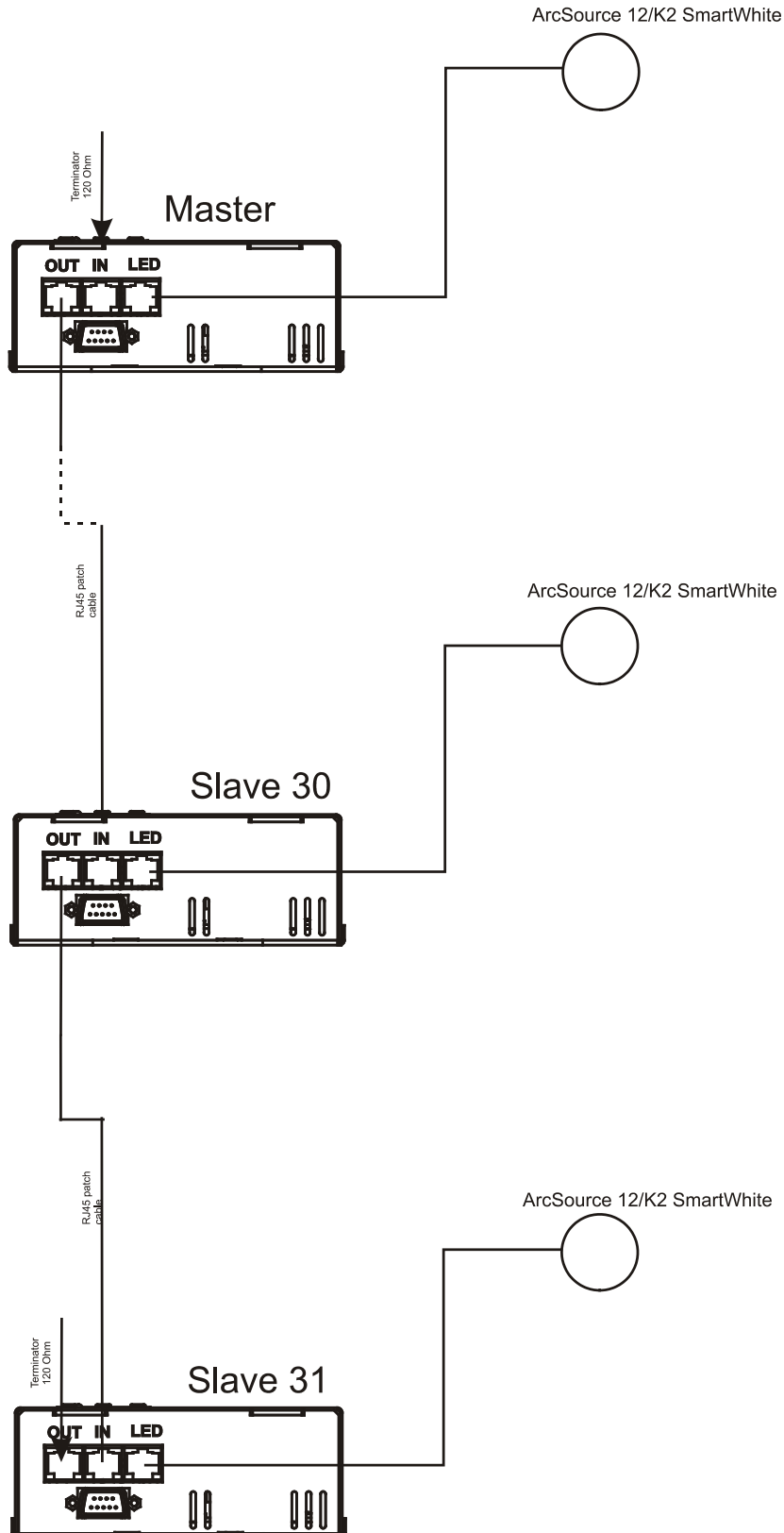

5.3. Operating via DyNet protocol

1. Unplug from the mains before installation.
2. Connect LED modules to the fixtures.
Connect first fixture to the control panel which supports DyNet protocol.
3. Connect the DMX output of the first fixture in a data link with the DMX input of the second fixture. Always connect output with the input of the next fixture until all fixtures are connected. Up to 32 fixtures can be connected in data chain.
4. Insert the termination plug (with 120 Ohm) into DMX output of the last fixture in order to ensure proper transmission on the data link.
5. Connect fixtures to the mains
6. Select the DyNet protocol on all fixtures (menu SPE"---> Prt---> "dYn").

A description of each byte in the DyNet protocol is the following:

Byte 0: 1C - hexadecimal Logical Message (fixed value)
Byte 1: 01 - Area
Byte 2: 00 - Channel level
Byte 3: 80 - Channel
Byte 4: ff - Channel Offset
Byte 5: 00 - Fade Rate
Byte 6: FF (fixed value)
Byte 7: 1C Checksum

Area - (0 to 255), as set on the Arcpower to give a unique address for each Arcpower unit (i.e. DMX base address)

Channel Level - (0 to 255), level - 01=100%, FF=0%

Channel - (80 to 83), 80= channel 1, 81= channel 2, 82= channel 3, 83= channel 4, (see Channel Offset if more than 4 channels)

Channel Offset - (0-255), default (FF)- channel offset in blocks of 4: (FF = CH 1-4, 00 = CH 5-8, 01 = CH 9-12, etc up to 3E = CH 253-256)

Fade Rate - (0-255), fade rate with 1 second resolution (0= 0 seconds, 255= 255 seconds)

Checksum - (0-255), checksum Byte - used to ensure the integrity of the packet.
Negative two's compliment of the preceding 7 bytes.

Example 1:

0x1C,0x10,0x00,0x80,0xff,0x05,0xff,0x52

This would control channel 1 (i.e. Red) of Arcpower unit, address 16 to a Level of 100% with a fade of 5 seconds.

Example 2:

0x1C,0x05,0xCC,0x82,0xff,0x0A,0xff,0x52

This would control channel 3 (i.e. Blue) of Arcpower unit, address 5 to a level of 20% with a fade of 10 seconds.

6. ArcPower SmartWhite 36/K2 - Control menu map

Default settings=**Bold print**

001 (001-509)

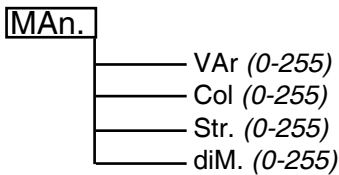
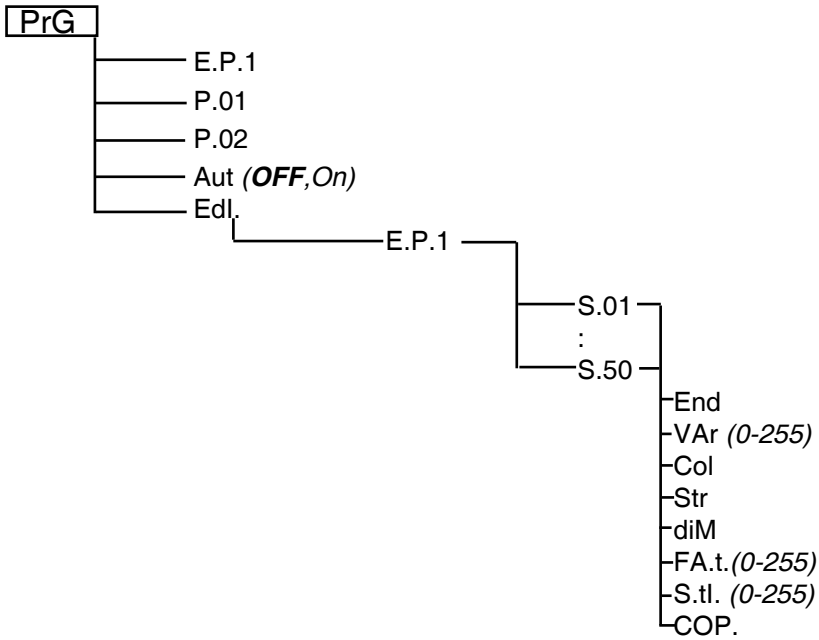

tSt

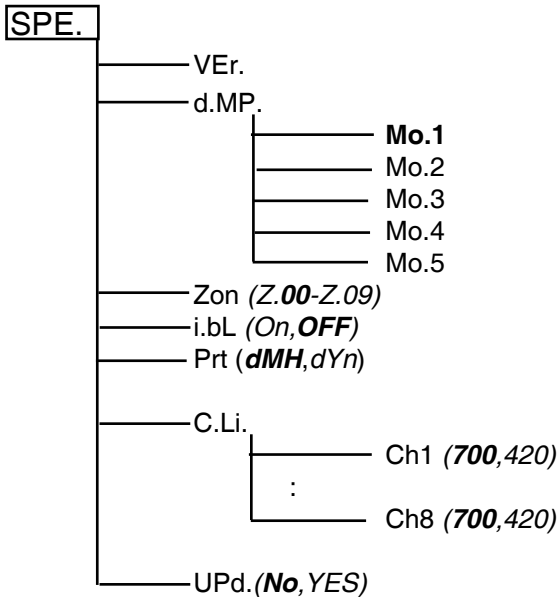
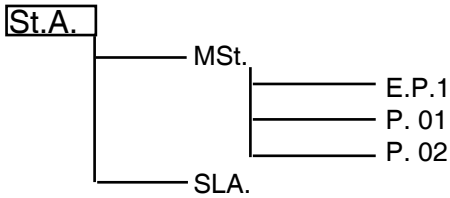

7. ArcPower SmartWhite 36/K2 - DMX protocol

Version 2.0 (software version 1.1 and higher)

Mode/Channel					Value	Function	Type of control
1	2	3	4	5			
1	-		1	1	0-255	Warm white LEDs LEDs saturation control (0-100%)	proportional
2	-		2	2	0-255	Cool white LEDs LEDs saturation control (0-100%)	proportional
-	-	1	-	-	0-127 0-127 128-255 128-255	Ratio control * 100% Warm white LEDs saturation Cool white LEDs saturation 0%-->100% 100% Cool white LEDs saturation Warm white LEDs saturation 100%-->0%	step proportional step proportional
-	-	-	3	-	0-31 32-63 64-95 96-127 128-143 144-159 160-191 192-223 224-255	Shutter/strobe Shutter closed Shutter open Strobe-effect from slow to fast Shutter open Opening pulses in sequences slow--> fast Closing pulses in sequences fast --> slow Shutter open Random strobe-effects from slow to fast Shutter open	step step proportional step proportional proportional step proportional step
-	-	2	4	3	0-255	Dimmer Dimmer intensity from 0% to 100%	proportional
-	1	-	-	-	0-255	All LEDs ** All LEDs saturation control (0-100%)	proportional

* Ratio control:

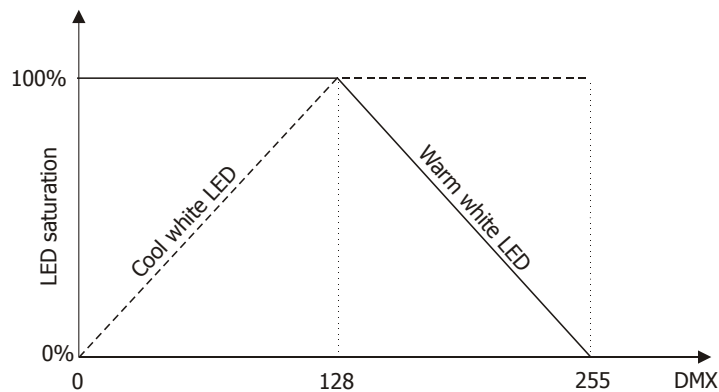

** The mode 2 is suitable for control of single colour modules.

8. Control board

The control panel situated on the top cover of the ArcPower SmartWhite 36/K2 allows DMX addressing, calling built-in programs and setting the fixture behaviour

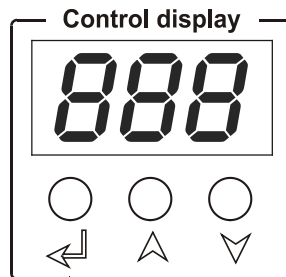

Control elements:

- ↵ [ENTER] button- enters menu, confirms adjusted values and leaves menu.
- ▲, ▼ [UP] button and [DOWN] button- moves between menu items on the the same level, sets values. In order to leave the menu without saving value, press [UP] and [DOWN] at the same time.

After switching on the ArcPower SmartWhite 36/K2 ,the display shows the initial DMX address:



Use [UP],[DOWN] to browse through the menu. To select a function or submenu,press [ENTER].

8.1 Addressing the ArcPower SmartWhite 36/K2



The fixture can be operated in the two modes:**DMX mode**-fixture is controlled via DMX 512 by an external DMX controller
Stand-alone mode - fixture uses build-in programs and is able to control other fixtures in the master/slave chain.
 See the chapter "Stand-alone mode" for detail description.

For DMX mode is important the DMX start address that is defined as the first channel from which the ArcPower SmartWhite 36/K2 will respond to the DMX controller.

Setting the DMX start channel for DMX operating:

1. Connect ArcPower SmartWhite 36/K2 to the mains.
2. Browse through the menu by pressing the [UP] and [DOWN] buttons until the display shows current address "001". Confirm by pressing [ENTER] button and "001" will start to flash frequently.
3. Use the [UP] and [Down] buttons to select the desired address.
4. Confirm by pressing [ENTER].

After having addressed ArcPower SmartWhite 36/K2, you may now start operating ArcPower SmartWhite 36/K2 via your DMX controller.

8.2 Program running



By enter to this menu a complete overview of all programs is offered,from which the program to be run can be selected by pressing [ENTER].Selected program runs in a loop.The fixture includes 2 built-in programs (P.01,P.02) and one free editable program (E.P.1) up to 50 steps.

If Item "Aut" is On,the fixture in DMX mode will remember last running program and this program will run after switching on the fixture.

Each program step has a fade time-the time during which effects go to the current step and a Standing time-the time,during which effects last in the current step.

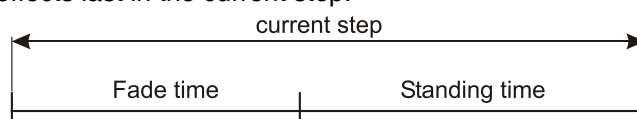

Programming procedure:

1. Enter "Edl." menu
2. Press [UP] or [DOWN] to select the desired program which you wish to edit and press [ENTER].
3. Press [UP] or [DOWN] to select the desired program step ("S.01" - "S.50") and press [ENTER].
4. Press [UP] or [DOWN] to select the desired item and press [ENTER]-button. Now you can edit by using [UP] or [DOWN] buttons the DMX values selected item (the list of items depends on selected DMX mode):

End. - a total number of the program steps (value 1-50). This value you must set before start programming (e.g. if you want to create program with 10 steps, set End=10).

VAR - a warm white LED saturation, value 0-255

Col - a cool white LED saturation, value 0-255

Str. - a strobe, value 0-255

dim. - a dimmer, value 0-255

FA.t. - fade time, value 0-255 *

S.tl. - standing time, value 0-255 *

COP. - copying the current prog. step to the next prog. step.

Press [ENTER]-button to confirm adjusted value .

5. Repeat steps 3 and 4 for next prog. step. If you want to copy current prog. step to the next prog. step, select option "COP." and confirm it by pressing [ENTER].

*Both Fade time and Standing time use the same conversion table in order to convert DMX value to the time value:

DMX	Time [sec.]	DMX	Time [min.]	DMX	Time [min.]	DMX	Time [min.]	DMX	Time [min.]
1	0.1	50	4.2	105	18.4	160	42.7	215	77
2	0.4	55	5	110	20.2	165	45.4	220	80.7
5	2.5	60	6	115	22	170	48.2	225	84.4
10	10	65	7	120	24	175	51	230	88.2
15	22.5	70	8.2	125	26	180	54	235	92
20	40	75	9.4	130	28.2	185	57	240	96
25	62.5	80	10.7	135	30.4	190	60.2	245	100
30	90	85	12	140	32.7	195	63.4	250	104
35	122.5	90	13.5	145	35	200	66.7	255	108
40	160	95	15	150	37.5	205	70		
45	202.5	100	16.7	155	40	210	73.5		

Exact expression of the time value follows the formula: $\text{time}[\text{sec.}] = (\text{DMX value})^2 / 10$.

8.3 Manual mode



This menu gives access to the control of the fixture channels by means of the control buttons.

Use [UP] and [DOWN] buttons until the display shows "MAN." menu. Press [ENTER] button and by using [UP] and [DOWN] buttons select desired effect, press [ENTER] and and by using [UP] and [DOWN] buttons adjust desired DMX value for selected effect. Confirm by [ENTER].

VAR a warm white LED saturation

Col a cool white LED saturation

Str. a strobe

dim. a dimmer

8.4 Test sequences



Use the item to run a special demo-test sequences without an external controller, which will show you some possibilities of using the fixture.

8.5 Stand-alone mode



Select this menu to set fixture behaviour in stand-alone mode without an external controller.

Synchronous operation of multiple fixtures requires that they must be connected on a data link and one of them is set as a master ("MSt") and the rest as the slaves ("SLA"). Only one fixture can be set as the master. The slaves mimic the behavior of the master. Effect actions are triggered by an internal timer of the master fixture.

Important!: Disconnect the fixtures from the DMX controller before master/slave operating, otherwise data collisions can occur and the fixtures will not work properly!

MSt. --- Master. Enter this menu if you want to set the the fixture as a master. Use [UP] and [DOWN] buttons to select desired program and press [ENTER] to confirm selection.

SLA. --- Slave. Enter this menu if you want to set the the fixture as a slave.

Note:

To run a master/slave operation, switch on all drivers at the same time or switch on the slaves as first and then the master fixture. The master fixture starts simultaneous program start in the other slave fixtures. All fixtures are synchronized in every prog.steps. The fixtures run their programs in a loop (e.g. if master runs its program „P02“, all slaves will be executed theirs programs „P02“ too).

If the master runs its editable program (EP1), all slaves will execute their own editable programs (EP1) according the master, but both fade time (FA.t.) and standing time (S.tl.) for each step will be taken from the master's step (slaves' times are eliminated in each step).

8.6 Special functions



Use this menu for special services.

VER. --- Software Version. Select this function to read the number of the fixture software.

d.MP. --- DMX presetting. The function makes possible to select from the 5 DMX- channels settings. Use [UP] and [DOWN] buttons to select desired channel mode ("Mo.1, Mo.2, Mo.3, Mo.4, Mo.5") and press [ENTER] to confirm selection.

Zon. - Zone selecting. The option enables select desired number of the zone (from 0 to 9). Use [UP] and [DOWN] buttons to select desired zone and press [ENTER] to confirm selection. Fixtures with the same zones will work in parallel if character sequences are used. ArcPower SmartWhite 36/K2 uses the 2 types of the zone character sequences:

1. Direct colour selection:

zone Z warm;
zone Z cool;
zone Z blackout

Z means number of zone (0-9)
; means end of character sequence

Example: zone 2 warm;

2. Optional colour adjustment:

zone Z w, c;

Z means number of zone (0-9)

w means value of the warm white colour (0-255)

c means value of the cool white colour (0-255)

; means end of character sequence

Values of colours have to be separated by a comma.

examples: zone 0 234, 126;
zone 1 5, 18;

**A serial port on your computer or light console should be configured as follows:
9600 Baud, 8 Data Bits, Non Parity, One Stop Bit, No Flow Control Required.**

i.bL. --- Initial blink. If this function is on, ArcPower SmartWhite 36 runs auto-calibration (All LEDs light on 100% for short time) after switching it on. If this function is set off, you have to set manually every colour on max.brightness after switching on the driver before starting regular operating. This action should last min. one second. In this moment, the ArcPower SmartWhite 36/K2 finds out the load connected to its LED output and makes auto-calibration.

Prt --- Protocol selection - Selects a required communication protocol.

dMH - the fixture will communicate using DMX 512 signal.

dYn - the fixture will communicate using the DyNet protocol.

C.Li. --- Current limiting.The menu item allows to set right current-carrying capacity of each LED branch (colour) in order to keep declared lifetime of LED modules:

Red,amber LEDs.....420 mA

Green,blue,warm white and cool white LEDs....700mA

The SW LED modules use 4 internal branches for LED supply and all items "**Ch1**","**Ch2**",...."**Ch8**" have to be set at correct values - see table below.

Single-colour variants of LED modules (e.g. R,G,B,A,WW,CW) use 3 internal branches for LED supply and the items "**Ch1**","**Ch2**", "**Ch3**" and "**Ch5**","**Ch6**","**Ch7**", have to be set at correct values - see table below

Examples of recommended settings for different LED colour combinations

Menu item	Colour combination (the same colour variants on both zones)							
	Zone	SW*	R	A	G	B	WW	CW
Ch1	1	700*	420	420	700	700	700	700
Ch2	1	700*	420	420	700	700	700	700
Ch3	1	700*	420	420	700	700	700	700
Ch4	1	700*	420	420	700	700	700	700
Ch5	2	700*	420	420	700	700	700	700
Ch6	2	700*	420	420	700	700	700	700
Ch7	2	700*	420	420	700	700	700	700
Ch8	2	700*	420	420	700	700	700	700

* default setting

To adjust the current limiting:

1. Browse through the menu by pressing the [UP] and [DOWN] buttons until the display shows "**C.Li.**" menu. Press [ENTER] button and "**Ch1**" item will appear on the display.
2. Press [ENTER] button again and use [UP] and [DOWN] buttons to select desired value. Confirm this value by pressing [ENTER]. Use the [UP] and [Down] buttons to select next colour (supply branch).
3. Repeat step 2 for items "**Ch2**", "**Ch3**", "**Ch4**", "**Ch5**", "**Ch6**", "**Ch7**" and "**Ch8**".

UPd. --- Software update - Using this function you can update software in the fixture via PC and serial link.

The following are required in order to update software:

- PC running Windows 95/98/2000/XP or Linux
- DMX Software Uploader
- Flash cable RS232/DMX (No.13050624)

Note1:Software update should execute a qualified person.If you lack qualification, do not attempt the update yourself and ask for help your ANOLIS distributor.

Note 2:DMX address,programs and all settings will be set to their default values.

To update software in the fixture:

1.Installation of DMX Software Uploader:

- 1.DMX Software Uploader program is available from the ANOLIS web site at WWW.anolis.cz.
- 2.Make a new directory (e.g. ANOLIS_Uploader) on your hard disk and download the software to it.
- 3.Unpack the program from the archives. Program file has name:DSU_name of corresponding fixture_SoftwareID.SoftwareID describes the versions of fixture software included in DMX Software Uploader. Higher number means later software versions.

2.Fixture software updating:

- 1.Determine which of your COM port is available on your PC and connect it with to the DMX input of the fixture using the Flash cable. Do not extend this cable! Disconnect the fixture from the other fixtures in DMX chain! Turn on the computer and the fixture.
- 2.Switch the fixture to the update mode by selecting the option Software update in menu Special Functions on the fixture control panel:SPE-->UPd-->yES.(From this option you cannot return back to the main menu. If you do not want to continue in software update, you have to switch off and on the fixture to leave this option!)
- 3.It is recommended that you exit all programs before running the Software Uploader.
- 4.Start the Software Uploader program. Select desired COM and then click Connect button. If the connection is OK, click Start Uploading button to start uploading. It will take several minutes to perform software update.All processors will be updated (including processors with the same

software version).

If you wish to update only later versions of processors, enable the Incremental Update check box. Avoid interrupting the process. Update status is being displayed in the list window.

When the update is finished, the line with the text "The fixture is successfully updated" will appear in this window and the fixture will reset with the new software.

Note: In the case of interruption of the upload process (e.g. power cut), the fixture remains in the update mode and you have to repeat the software update again.

For example: The fixture was switched off before finishing software upload. After switching the fixture on again, the fixture is still in the update mode and the display is dark. Restart the Software Uploader program and repeat software update from your PC.

9. Technical Specifications

Power supply:

Input Voltage: 100-240 V AC, 50/60 Hz

Fuse: T 2 A H

Max. Power Consumption: 120VA

Input:

Control: DMX 512 or DyNet protocol

DMX connection: RJ45

RS 232 connection: 9-pin D connector

Output:

Max. Output Voltage: 48V DC

Max. Output current: 700 mA per colour

Max. load: 36x K2 LED's

Maximum total cable length between ArcPower SmartWhite 36/K2 and all connected LED modules:

40 metres at max. load

DMX channels:

Channel	Mode 1	Mode 2	Mode 3	Mode 4	Mode 5
1	Warm white	All LEDs sat.	Ratio	Warm white	Warm white
2	Cool white		Dimmer	Dimmer	Cool white
3					Shutter
4					Dimmer

Control and programming:

Protocol: USITT DMX-512

Five DMX protocol modes

Control options: DMX, Auto-trigger

Operation modes: Master/Slave, Stand alone

Programs: 2 Built-in programs and 1 user editable program up to 50 steps

Display: 3 digit LED

Manual control of all DMX channels with LED control panel

Operating temperature:

-10°C/+40°C

Max. surface temperature:

+60°C

Dimensions(mm):

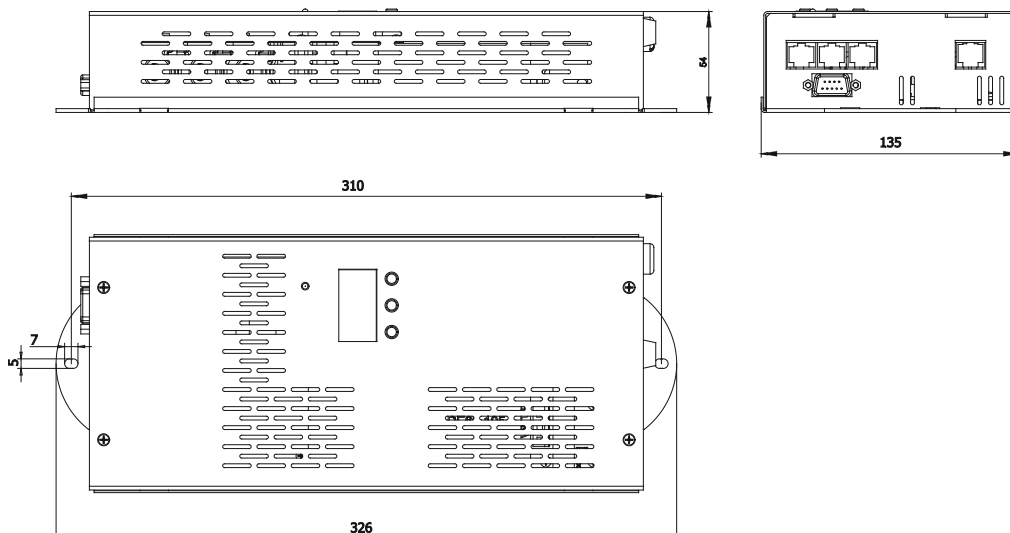

Weight:

1.8 kg

Accessories:

Cable joiner1piece

Optional accessories:

Adaptor RJ45/DMX 3 pin.....No.13050730

Adaptor RJ45/DMX 5 pin.....No.13050731

10. Replacing the fuse

1.Before replacing the fuse, unplug mains lead!

2.Unscrew the fuse holder on the rear side of the ArcPower SmartWhite 36/K2 with a fitting screwdriver from the housing (anti-clockwise).

3.Remove the old fuse from the fuse holder.

4.Install the new fuse in the fuse holder.

5.Replace the fuse holder in the housing and fix it.